

Type: EPV

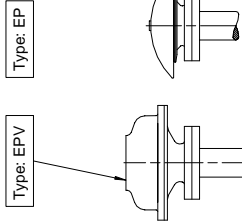

Type: EP

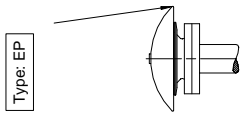

Type: AMO

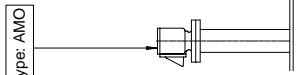

Type: M2  
Type: M3  
Type: M6

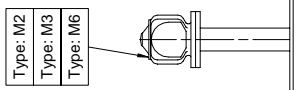

Type: M

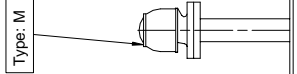

Type: EL-GAS

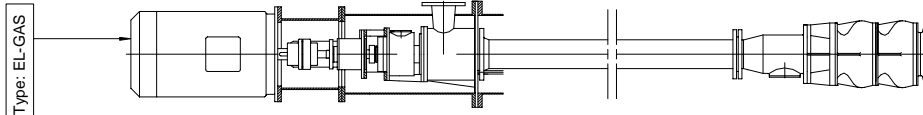

Type: EL-CHEM

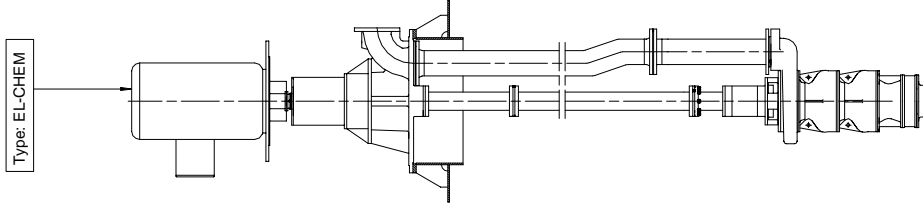

Type: VF  
Type: VFA  
Type: VFB  
Type: VFC

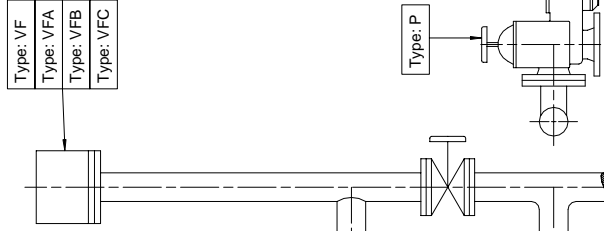

Type: N

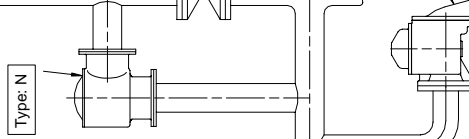

Type: DA  
Type: DH  
Type: DHV  
Type: DHM

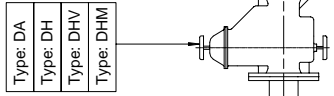

Type: G

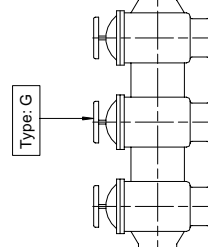

Type: P

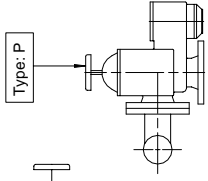

Type: GFB  
Type: GFC  
Type: AC  
Type: S  
Type: SC  
Type: VO  
Type: VOID

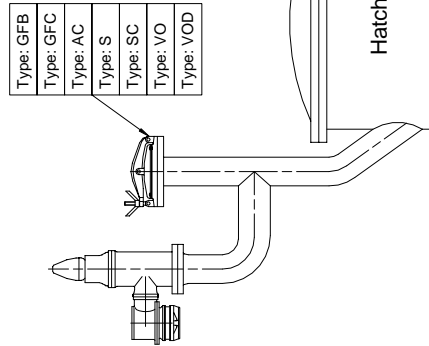

Type: FLS  
Type: GB  
Type: FLF

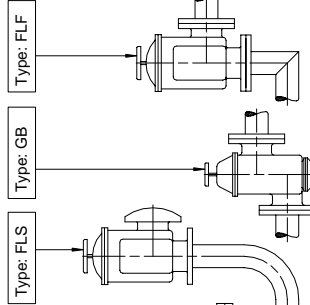

Type: PTRM

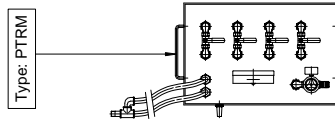

Type: TR  
Type: TRM

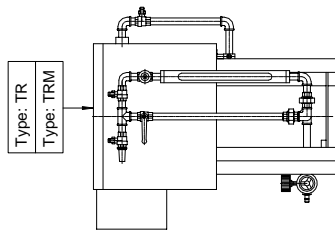

Type: OA

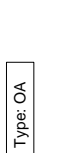

Hatch

Deck

**PREIS-VAO**

Date: 030807

Draw. Rev: 0

Draw. no.: ~

Score: ~

Drwg. no.: ~

TYPE INDEX

Page 2

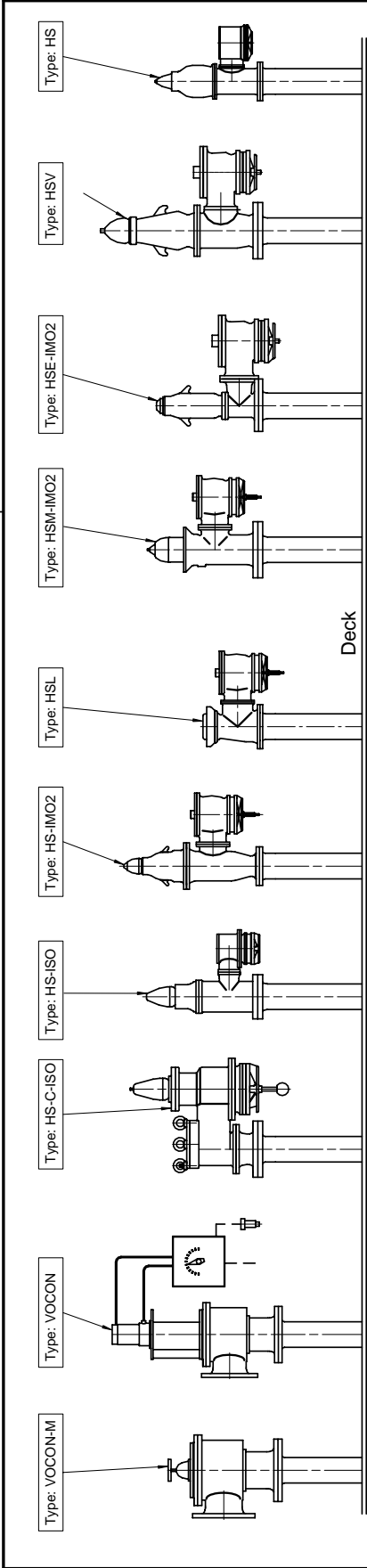

Deck

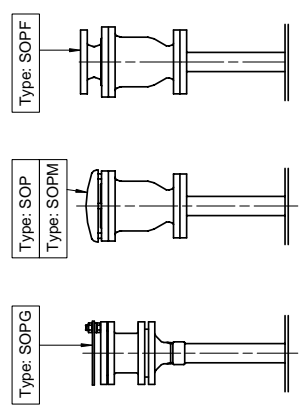
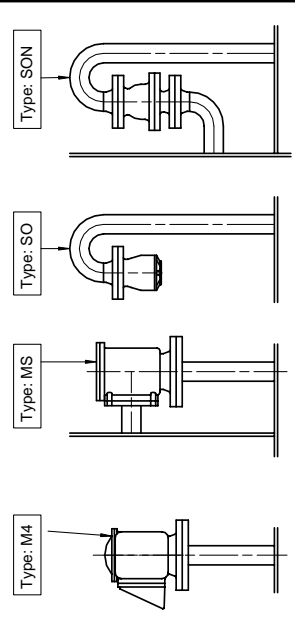

<b>PREIS-VAO</b>	Date: 030807	Drawg.: AP
	Drw. Rev.: 0	Scale: ~
<b>TYPE INDEX</b>		Drawg. no.: <b>Page 1</b>

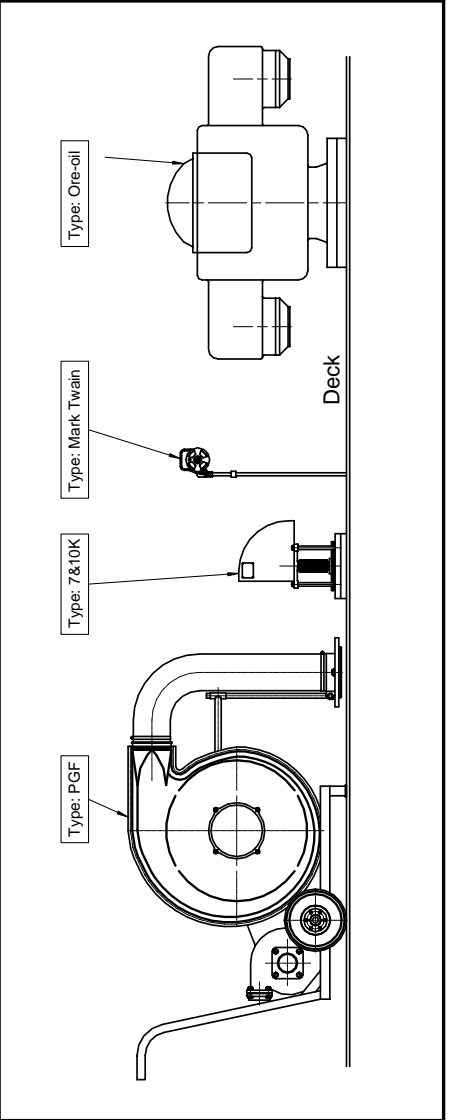
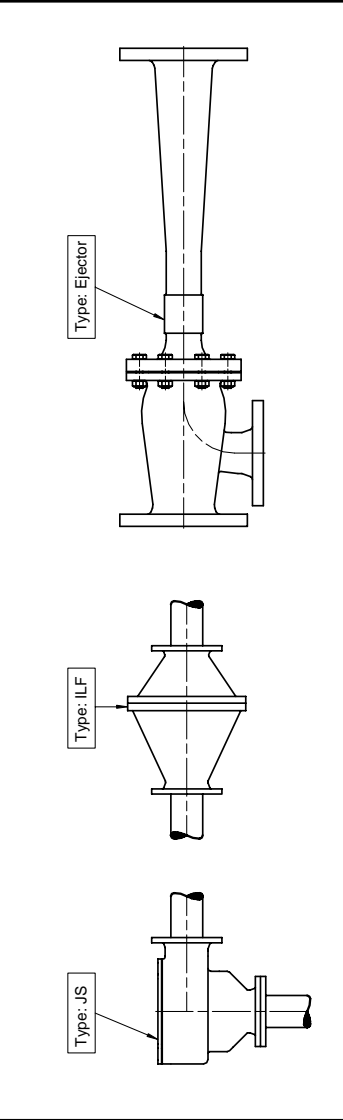

Deck